

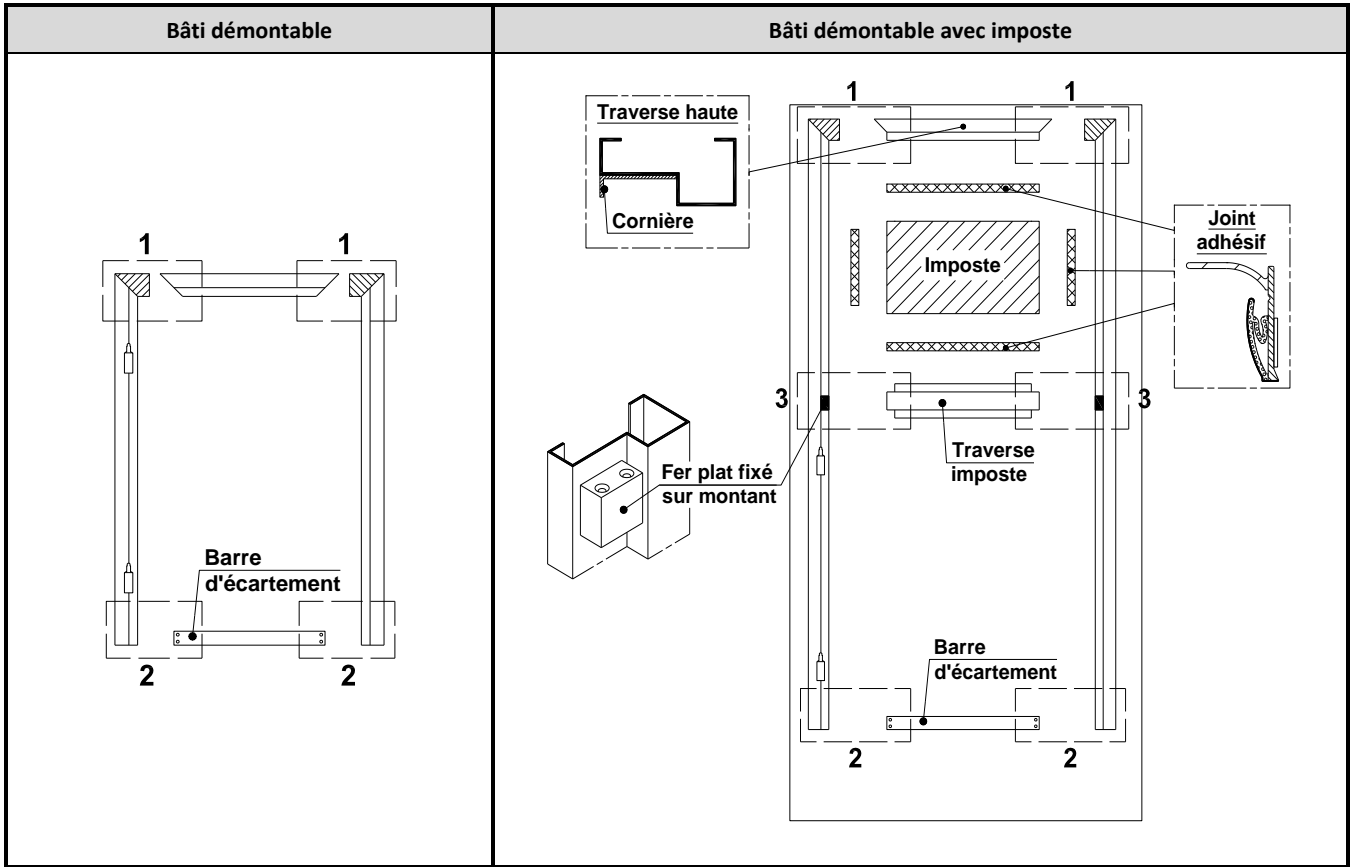





BATI DEMONTABLE

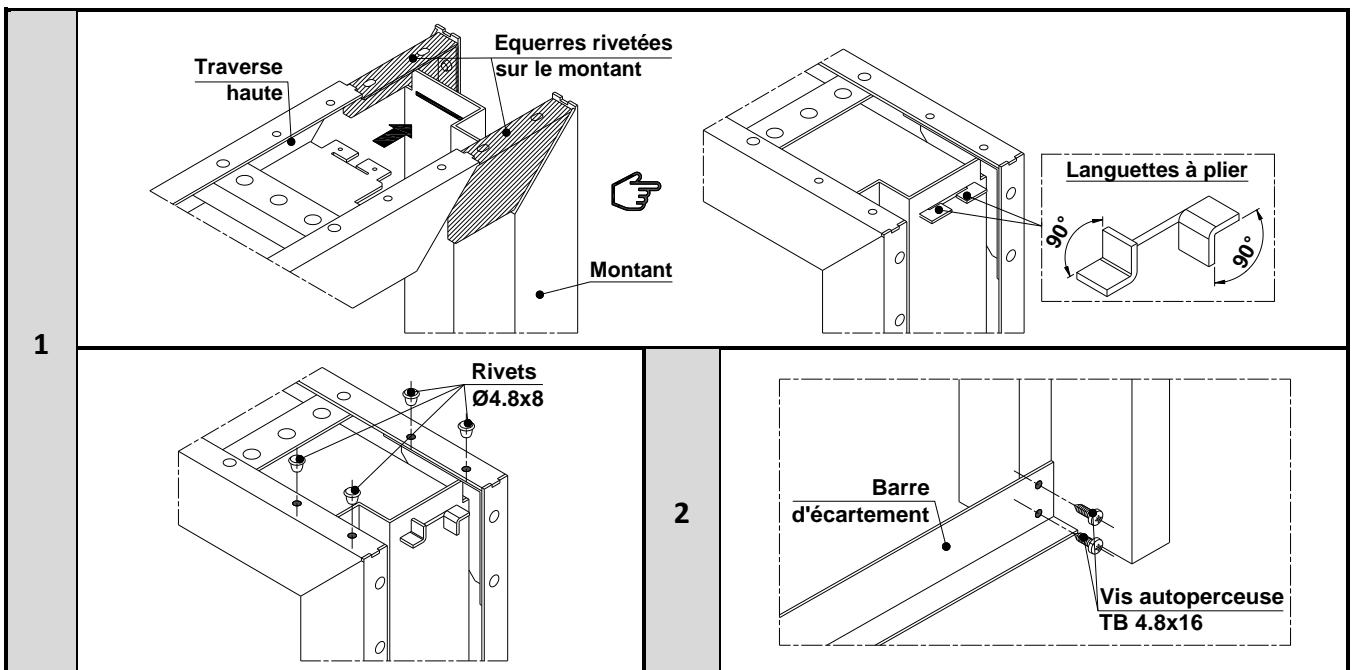

Fourni pour bâti démontable	8 rivets aveugles Ø4.8x8 	4 vis autoforeuses TB 4.8x16 
-----------------------------	---	---

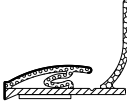

Fourni pour imposte démontable	4 vis CHC M8 tête plate	4 bouchons	Joint adhésif	4 vis autoforeuses TB 4.8x45
				

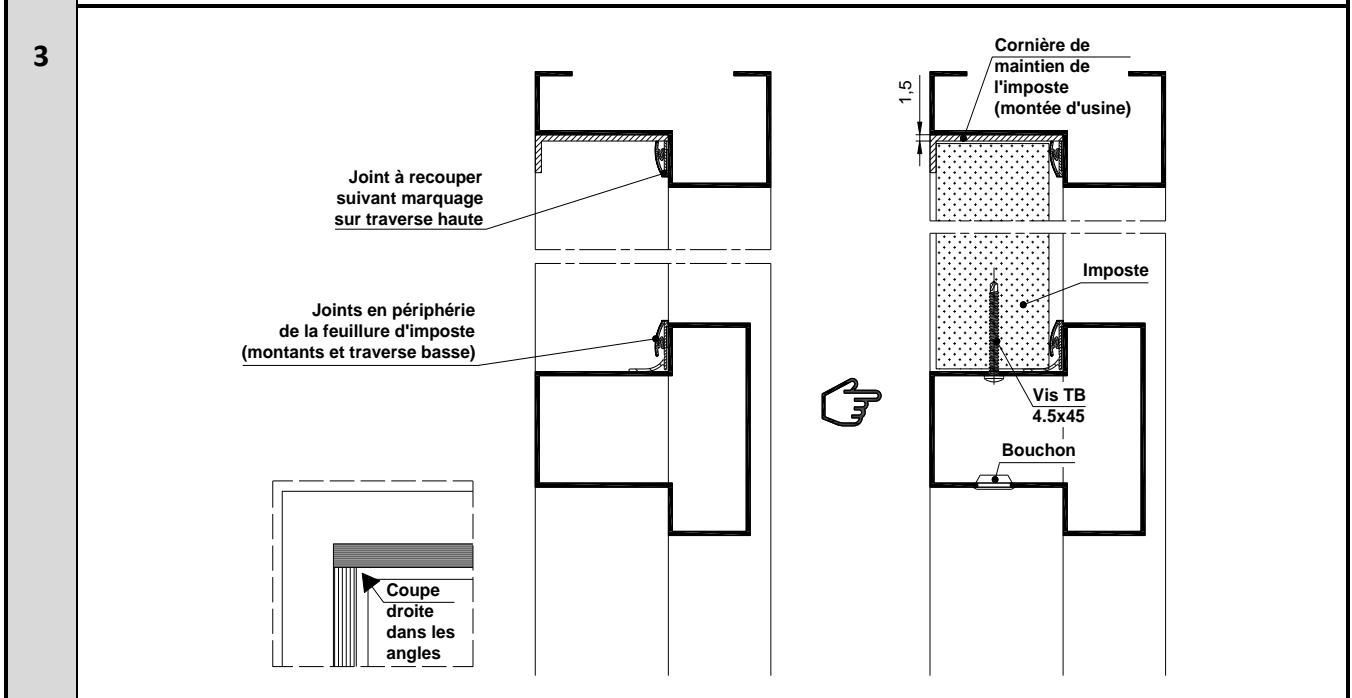
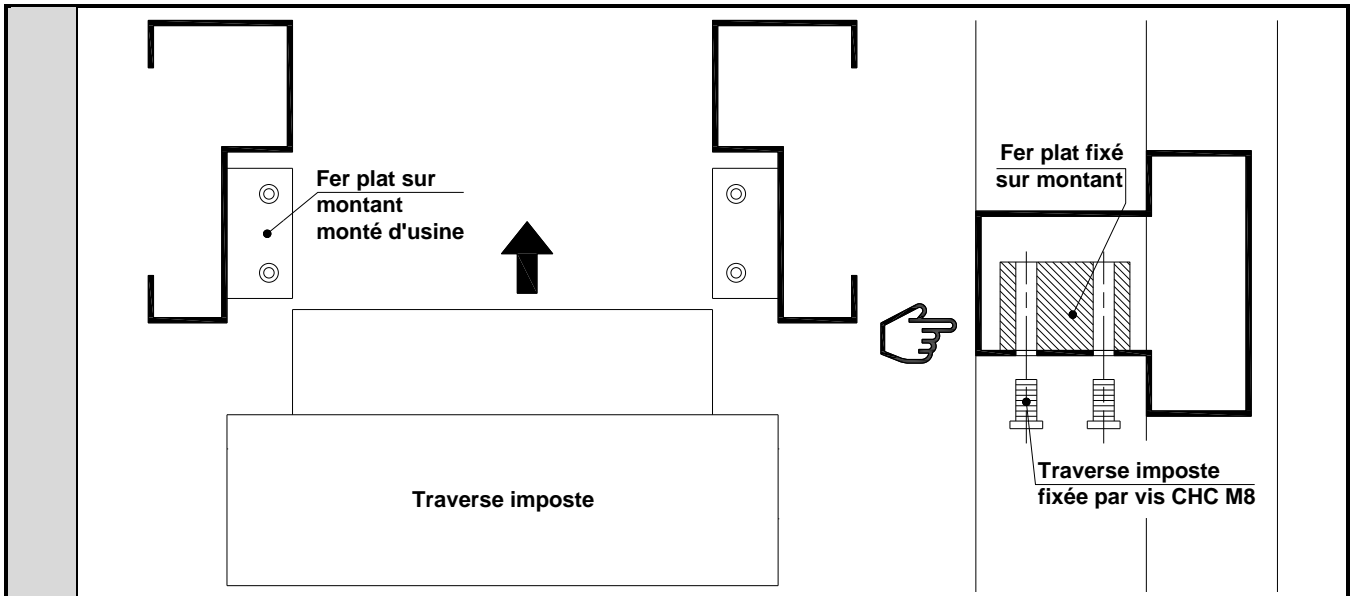

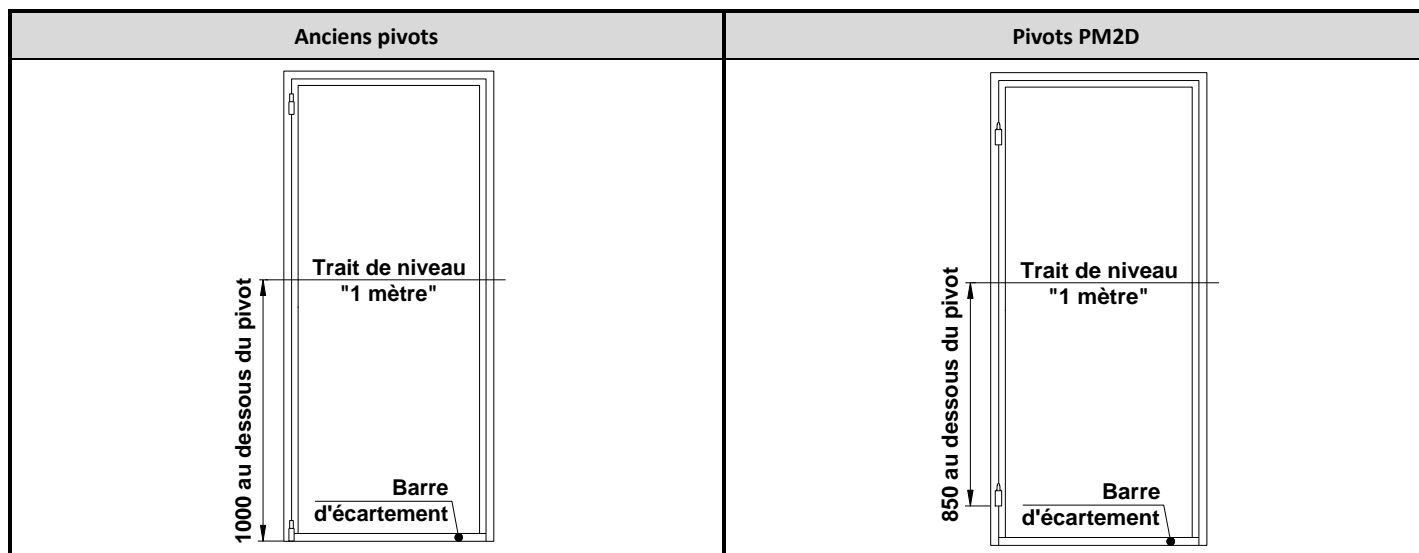

TRAIT DE NIVEAU « 1 METRE »





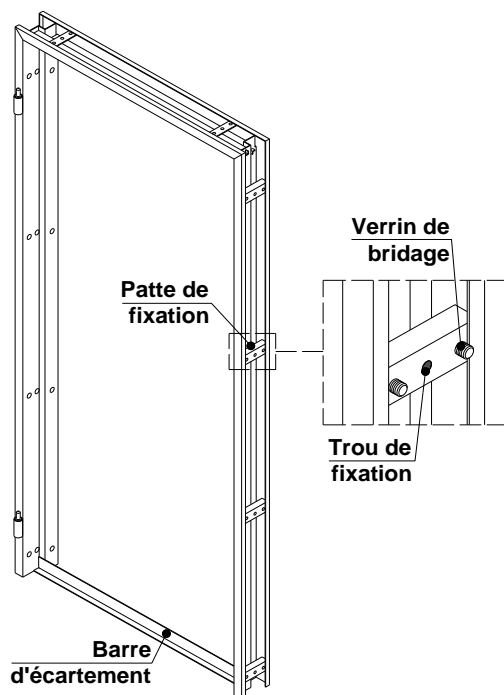

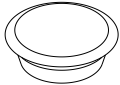

Lors de la pose du bâti vérifier l'aplomb, l'équerrage de la traverse haute et le parallélisme des montants. S'assurer que les montants et la traverse ne soient pas cintrés.

BATI A VISSER



Fourni	Remplissage des bâtis des portes M101LS / M101LSA / M102LS / M102LSA.	Tresse ISOVER 511 Ø30
	Bouchon.	
	Joint adhésif.	

Fixation (Non fournie)	Fixation murale des bâtis.	Cheville métal avec cône Ø8x72		
	Fixation des bâtis sur ossature métallique.			
		Vis CHC M8	rondelle	écrou
				
		Vis autoperceuse TH 6,3 et/ou soudure		
	L'utilisation de cheville plastique est strictement interdite			

1- Portes M101LS / M101LSA / M102LS / M102LSA - Remplir obligatoirement le bâti avec la tresse ISOVER 511 Ø30.

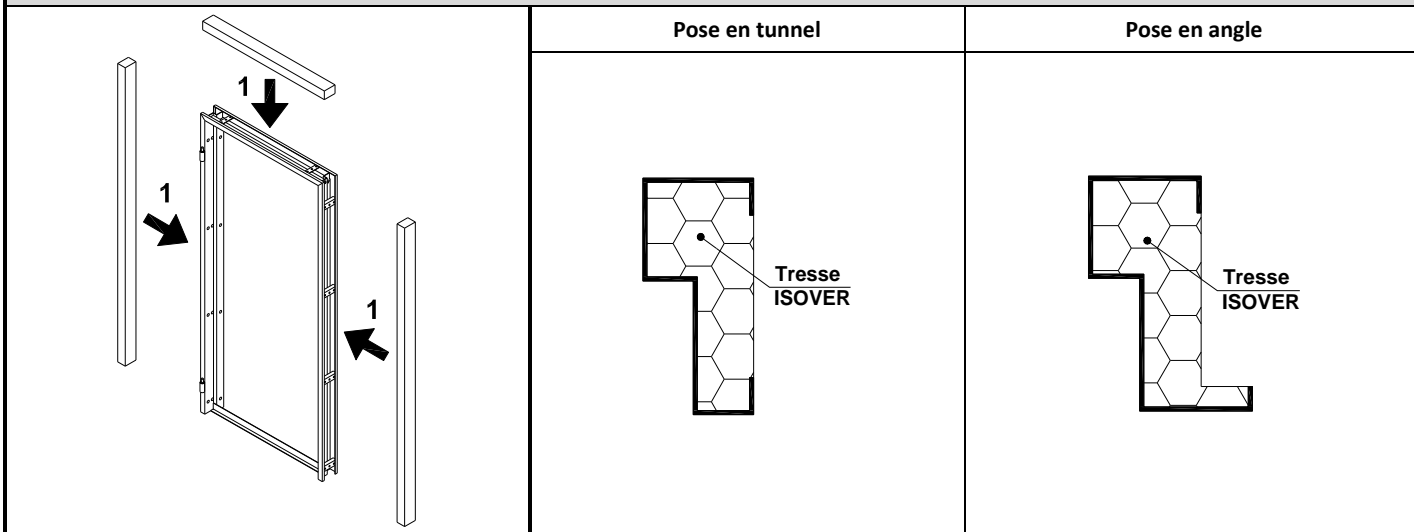

2-3-Positionner et centrer le bâti dans sa réservation.
 4-Brider le bâti et corriger si nécessaire l'équerrage du bâti.

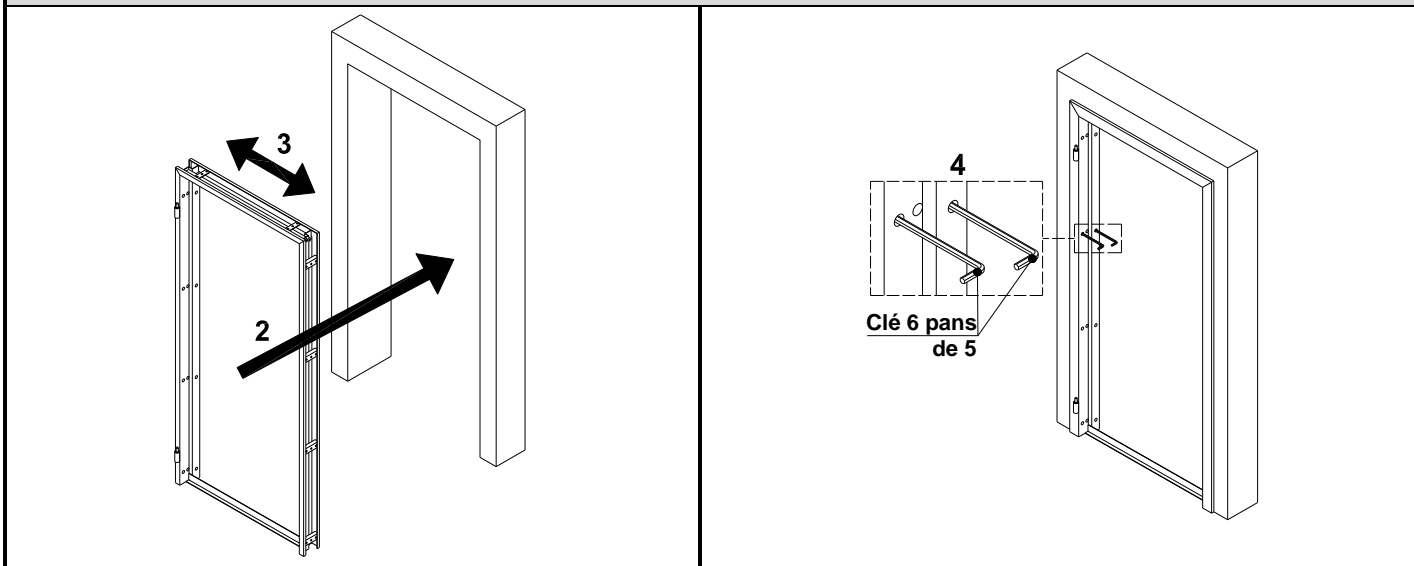

Pose en tunnel

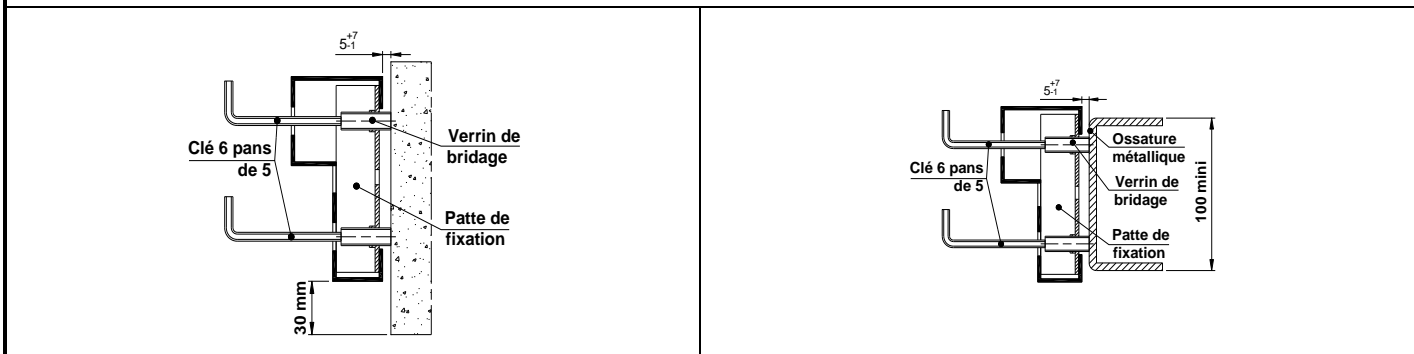

Pose en angle

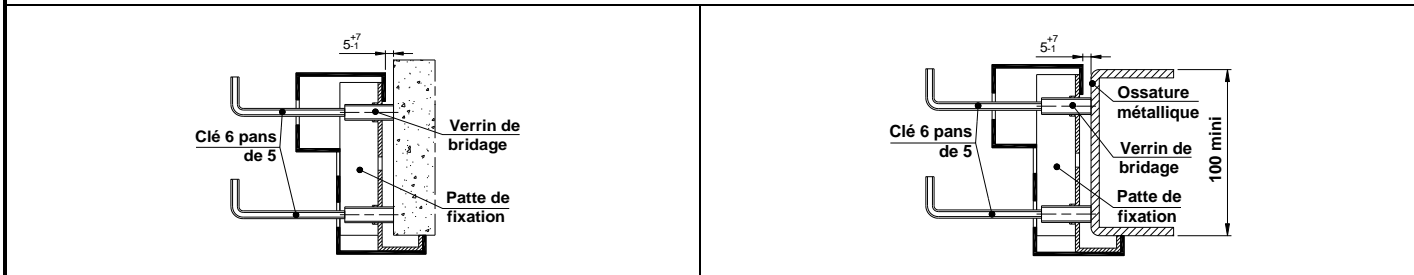

5-Fixer le bâti.

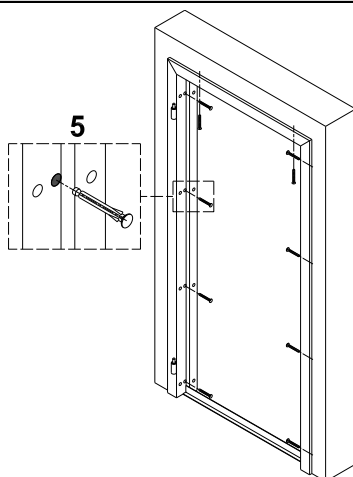

Pose en tunnel

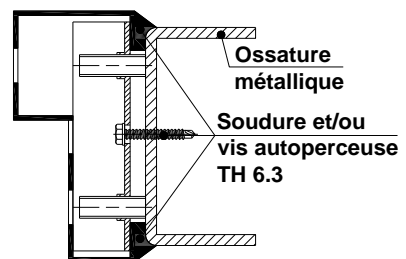
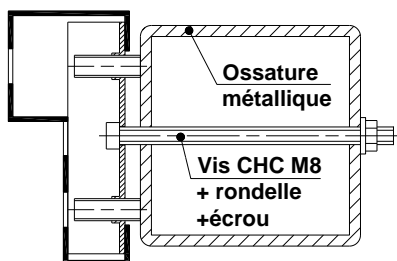
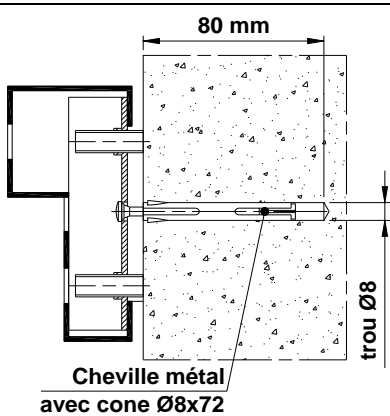

Pose en angle

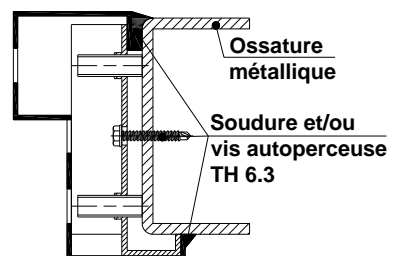
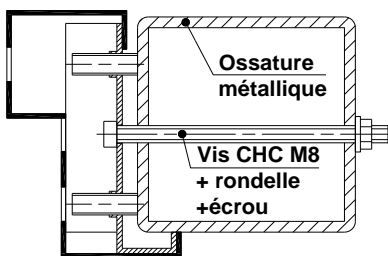
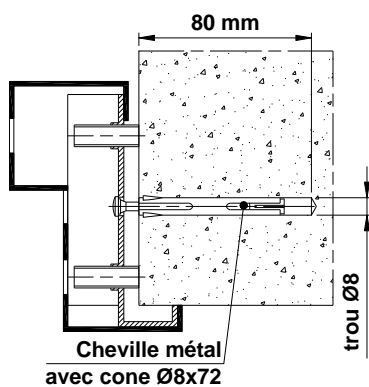

6-Pose des bouchons.

7-Réalisation de l'étanchéité périphérique éventuelle (cordon de joint silicone neutre).

8-Oter la barre d'écartement.

9-Pose du joint adhésif.

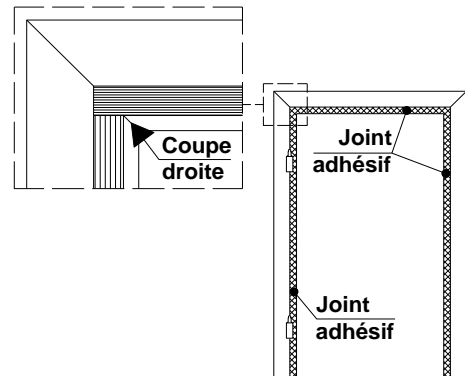
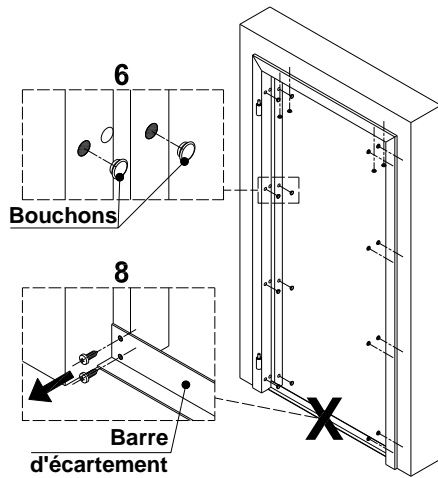

Pose en tunnel

Pose en angle

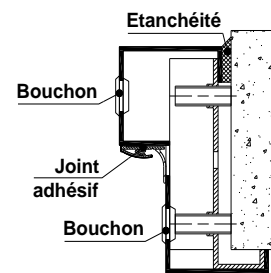
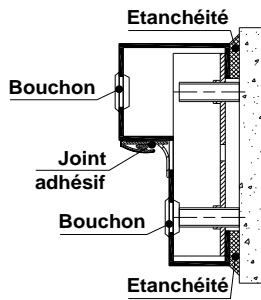

SEUIL DEMONTABLE



La pose du seuil est obligatoire pour les portes M101LS, M101LSA, M102LS et M102LSA.

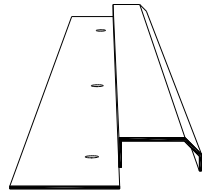

Joint adhésif

Joint à couper
Suivant marquage

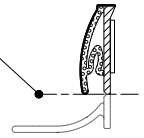

Etanchéité pour porte
donnant sur l'extérieure
(non fournie)

Joint

Chevilles Ø6x30
et vis TBØ4x35
(non fournies)

